

Signet 4150 Turbidimeter

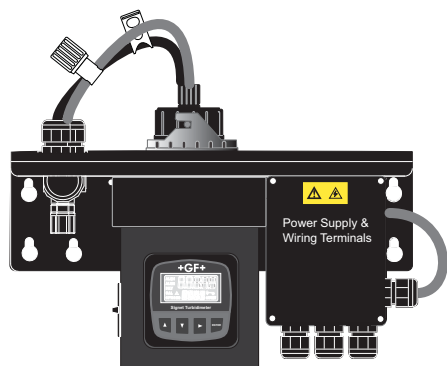

3-4150.090 Rev. R 04/17

Operating Instructions



Description

The Signet 4150 Turbidimeter provides accurate and reliable water quality monitoring for municipal and industrial applications.

The 4150 uses the Nephelometric method to calculate the turbidity of a sample as it flows through a viewing chamber. Models are available that use white light technology as required by the U.S. EPA 180.1 standard, or select the models that use infrared technology as required by ISO 7027.

Periodic calibration is mandatory with most turbidity systems, and the 4150 makes it fast and easy with sealed, reusable primary calibration standards.

Two dry contact relays serve as high or low alarms, with programmable setpoints and time-based delays to prevent false alarms.

Additional features include a bright backlight for the display and a convenient holder for the cuvette during calibration.

An ultrasonic automatic cuvette cleaning system is standard for 0 to 100 NTU/FNU systems and optional for 0 to 1000 NTU/FNU systems.

Table of Contents

Warranty Statement.....	2
Product Registration.....	2
Safety Information.....	2
Disclaimer.....	2
4150 Turbidimeter Parts.....	2
Specifications.....	3
Dimensions.....	3
Installation and Commissioning.....	4
Mounting Procedure.....	4
Preassembly.....	4
Plumbing.....	5
Electrical Connections.....	6
Overview of the Display and Keypad.....	7
Display Icons and Functions.....	7
Security Feature.....	8
Access to CALIBRATE Menu.....	8
Access to OPTIONS Menu.....	8
Calibration Standards.....	9
Calibration Procedure.....	10-11
OPTIONS Menu.....	12
Configuring the 4 to 20 mA Output.....	12
Configuring the RS-485 Output.....	13
Modbus RS-485 Output and Commands.....	14-16
Options: Alarm Relays.....	17
Options: Instrument Offset.....	18
Options: Extended.....	19
Vapor Purge System.....	20
Replacing Desiccant.....	20
Cleaning the Flow-Through Cuvette.....	20
Ultrasonic Cleaning.....	21
Troubleshooting.....	22
Notes.....	23
Ordering Information.....	24



- [English](#)
- [Deutsch](#)
- [Français](#)
- [Español](#)



NOTE: This manual is for 4150 Turbidimeters manufactured after 3/10/2010. If your menus look different than what is shown in this manual, you have the earlier version. That manual (rev G) is available in the Archived Products section at www.gfsignet.com.

Warranty Information

Refer to your local Georg Fischer Sales office for the most current warranty statement.

All warranty and non-warranty repairs being returned must include a fully completed Service Form and goods must be returned to your local GF Sales office or distributor. Product returned without a Service Form may not be warranty replaced or repaired.

Signet products with limited shelf-life (e.g. pH, ORP, chlorine electrodes, calibration solutions; e.g. pH buffers, turbidity standards or other solutions) are warranted out of box but not warranted against any damage, due to process or application failures (e.g. high temperature, chemical poisoning, dry-out) or mishandling (e.g. broken glass, damaged membrane, freezing and/or extreme temperatures).

Product Registration





Thank you for purchasing the Signet line of Georg Fischer measurement products.

If you would like to register your product(s), you can now register online in one of the following ways:

- Visit our website www.gfsignet.com. Under **Service and Support** click on **Product Registration Form**
- If this is a pdf manual (digital copy), [click here](#)

Safety Information

This manual contains basic instructions that must be followed during the commissioning, operation, care and maintenance of the instrument. The safety protection provided by this equipment may be impaired if it is commissioned and/or used in a manner not described in this manual. Consequently, all responsible personnel must read this manual prior to working with this instrument.

	Caution / Warning / Danger Indicates a potential hazard. Failure to follow all warnings may lead to equipment damage, injury, or death
	Electrostatic Discharge (ESD) / Electrocutation Danger Alerts user to risk of potential damage to product by ESD, and/or risk of potential injury or death via electrocution.
	Do Not Use Tools Use of tool(s) may damage product beyond repair and potentially void product warranty.
	Do Not Freeze (Calibration Standards) Products are temperature sensitive and may contain freezable liquids. Freezing damage voids accuracy.

Disclaimer

Georg Fischer Signet LLC accepts no responsibility for damage caused by the introduction of vapors, fluids or other materials into the instrument process stream which is not compatible with the wetted materials. A list of the wetted materials can be found in the specifications on page 3 of this manual.

Material Safety Data Sheets (MSDS) are available online at www.gfsignet.com

It is the responsibility of the Distributor, Dealer, or Agent to provide a current copy of the MSDS to the Consumers of Georg Fischer Piping Systems products. The information contained herein is presented in good faith and has been compiled from sources believed to be reliable. It represents the best information currently available to us. No warranty express or implied, or merchantability, fitness or otherwise is made and we assume no liability resulting from its use. This information is offered for your consideration and users should make their own investigation and verification to determine the suitability of the information for their particular purposes. In no event shall Georg Fischer Piping Systems, the parent company or its subsidiaries be liable for any claims, losses, or damages of any third party or for lost profits or any special, indirect, incidental, consequential or exemplary damages, howsoever arising, even if Georg Fischer Piping Systems has been advised of the possibility of such damages. This information relates to the material designated and may not be valid for such material used in combination with any other materials nor in any process.

4150 Turbidimeter Parts

Unpacking and Inspecting the Instrument and Accessories

The table below indicates the items in the Turbidimeter shipment.

Qty	Item
1	3-4150- (__) Turbidimeter
1	3-4150.090 Instruction Manual
1	3-4150.380 Desiccant Pack (Do not open until ready to install)
1	4150-0009 or 4150-0004 Measurement Cuvette
1	4150-0005 Tubing Kit:
1	shutoff clamp
1	backpressure valve
2	connectors and inserts [customer-supplied 8 mm (5/16 in.) tubing]
2	connecting tubing with fittings for flow-through assembly
1	drain vent screw (used in pressurized systems)
1	Mounting Hardware Kit

Remove the instrument from the packing carton.

Carefully inspect all items to ensure that no visible damage has occurred during shipment.

If the items received do not match the order, please immediately contact the local distributor or the Georg Fischer Signet Customer Service department.

Specifications

Measurement Range 0 to 100.0 NTU or 0 to 1000.0 NTU
(NTU = FNU = FTU)

Accuracy:

< 40 NTU $\pm 2\%$ of reading or ± 0.02 NTU
whichever is greater
> 40 NTU $\pm 5\%$ of reading
Resolution 0.0001 NTU (below 10 NTU)
Response Time Adjustable

Display Multi-Line LCD with backlighting
Alarm Relays (2) 120 to 240 VAC, 2A Form C Relay
Current Output Active 4 to 20 mA, 600 Ω
Digital Output RS-485

Wetted Materials

Tubing Vinyl
Measuring Cuvette Borosilicate Glass
Glass Washer Seal Silicone
Pressure Regulator Polypropylene, FKM,
316 Stainless Steel,
Polyoxymethylene (POM)
Inlet Tube 316 Stainless Steel
Maximum Inlet Pressure Recommended 345 kPa (50 psi)
based on tubing connection
provided
Pressure Regulator Rated up to 200 psi
Flow Rate 0.1 L/m to 1 L/m
(0.026 GPM to 0.26 GPM)
Operating Temperature 1 °C to 50 °C (34 °F to 122 °F)
Sample Temp. Range 1 °C to 50 °C (34 °F to 122 °F)
Power Supply 100 to 240 VAC, 47 to 63 Hz, 80 VA
(12 to 24 VDC option available.
Contact factory)
Insulation Rating Double Insulated
Pollution Degree 2
Over voltage Category II
Altitude 2000 meters (6562 ft) maximum
Relative Humidity Maximum 95% RH non-condensing
Enclosure Rating Power Supply Box: NEMA 4X / IP66
Environmental Conditions Not recommended for outdoor use
Shipping Weight 2.5 kg (5.5 lb)

Standards and Approvals

CE, WEEE, RoHS Compliant
White Light version Compliant to U.S. EPA 180.1
Infrared version Compliant to ISO 7027
ETL Listed UL 61010-1 and CSA C22.2
No. 61010-1

 China RoHS (visit www.gfsignet.com for details)

 This device complies with Part 15 of the FCC rules.

Operation is subject to the following two conditions:

- (1) This device may not cause harmful interference, and,
- (2) This device must accept any interference received,
including interference that may cause undesired operation.

Dimensions

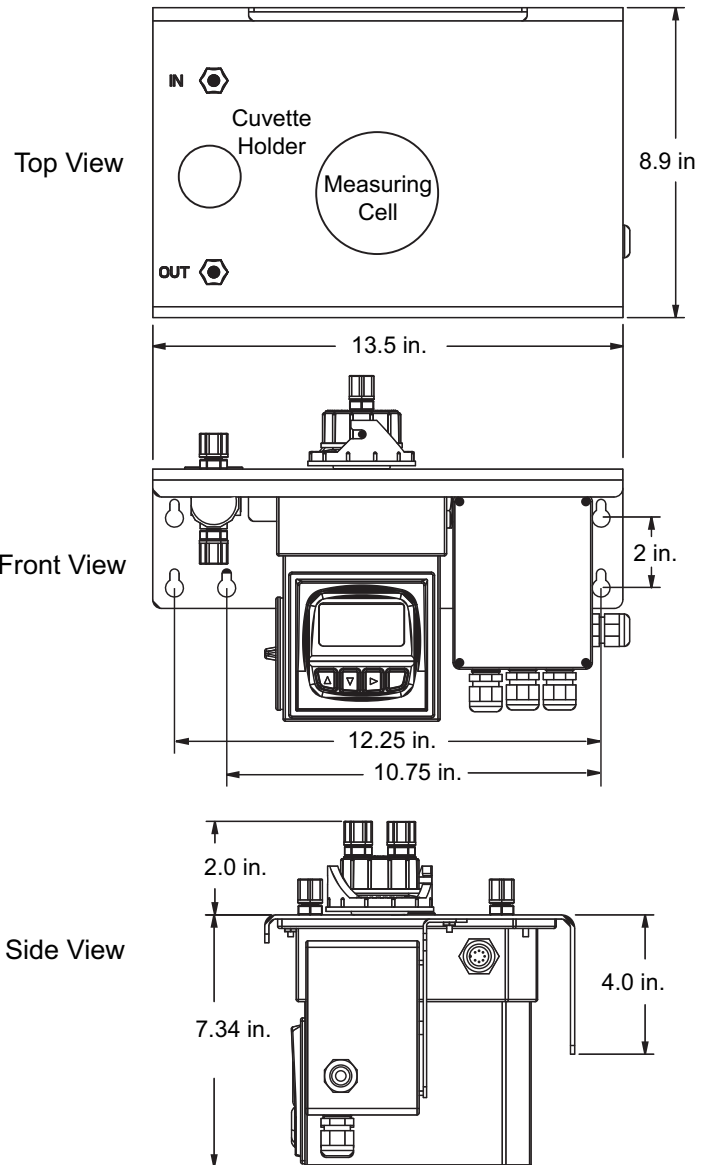

Installation and Commissioning

Mounting & Site Selection

The 4150 is designed to be wall mounted. If wall mounting the instrument is not a practical option, it can be mounted on any suitable level surface.

Four M6 (14 x 1 ¼ in.) pan head screws and four plastic wall anchors are provided to mount the Turbidimeter.

- Mount the 4150 within 2 m to 3 m (6 ft to 10 ft) of the sampling point to ensure a quick response time.
- It is recommended an isolation valve (NOT provided) be used to interrupt the inlet flow to the Turbidimeter.
- For ease of service there should be about 20 cm (8 in.) free area above the instrument for calibration and cuvette maintenance.
- Choose a location that is easily accessible for operation and service.
- The display should be positioned at eye level.
- The overall mounting dimensions of the instrument are shown on page 3. A mounting template is provided.
- Mount the Turbidimeter according to local electrical, building, and plumbing codes and seismic requirements.

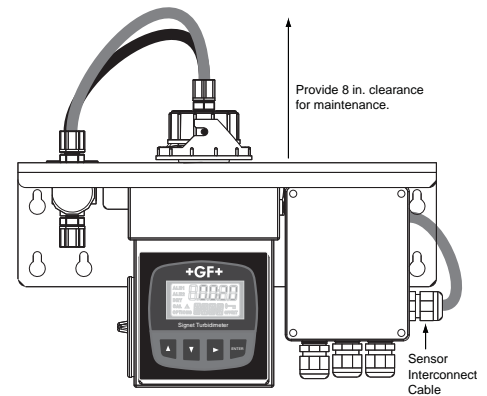

Mounting Procedure

1. Take a water-level and a pencil and use the mounting dimensions illustrated on page 3 to mark four mounting hole locations on the mounting surface.

NOTE: Refer to the full scale mounting bracket template for easy mounting.

2. Drill four holes for M6 (14 x 1 ¼ in.) screws into the mounting surface and insert four plastic wall anchors into them.
3. Use M6 (14 x 1 ¼ in.) screws and a Phillips screwdriver to fix the instrument to the mounting surface.

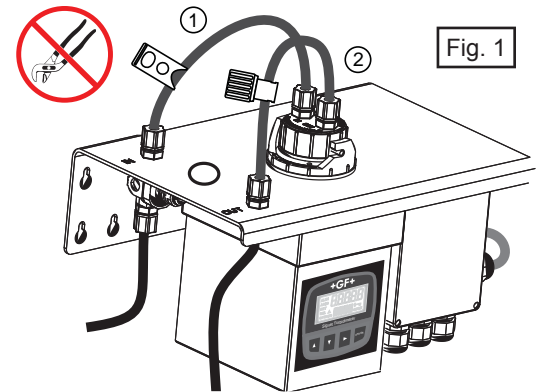

Preassembly

Install Connection Tubes To The Measuring Cell:

1. Locate Tubing Kit 4150-0005 and install the tube kit with the shutoff clamp (labeled "IN") to the nipple assembly marked "IN" on the Turbidimeter and to the measuring cell nipple marked "IN". See Fig. 1.
2. Install the tube kit with the small back pressure valve to the nipple assembly marked "OUT" on the top right front corner of the turbidimeter and to the measuring cell nipple marked "OUT". See Fig. 1. **NOTE:** Hand tighten only. Do not use any tools.

Install the Glass Cuvette: (See Fig. 2 and 3)

The Calibration Kit should be available for this procedure.



CAUTION:

Risk of impairment of the instrument's performance and damage to the internal electronics of the instrument.

Fluid, moisture, or debris can intrude into the instrument through the measuring cell opening. Cover the measuring cell opening while the cuvette is being installed.

- Clean and dry the external surface of the cuvette glass (and transducer) completely from fluid, moisture, or debris with the special cleaning cloth that is supplied with the calibration kit.
 - Ensure the cuvette is not leaking fluids before placing it back in the measuring cell.
 - Leave the measuring cell open only as long as necessary.
1. Locate and have ready the special cleaning cloth that comes with the Calibration Kit.
 2. Locate the glass measuring cuvette.

NOTE: Use the special cleaning cloth that comes with the calibration kit when handling the cuvette in order to avoid scratching or marking the glass surface of the cuvette. Substances on the surface of the glass will cause errors in the measurement.

3. Remove the glass cuvette from its shipping package.
3. Unlock the measuring cell by holding the measuring cell with one hand and twisting the measuring cell lock ring counter-clockwise.
4. Inspect the red gasket in the measuring cell for any defects, tears or dirt. Clean or replace if necessary.
5. Carefully thread the glass cuvette on the measuring cell. Hand tighten, being careful not to over tighten the cuvette. Over-tightening may cause the cuvette to crack or break.
6. Clean the glass cuvette with the special cleaning cloth that comes in the Calibration Kit. Do not use any other cloth.
7. Insert the measuring cuvette assembly back into the instrument and rotate the locking ring clockwise to secure the assembly.

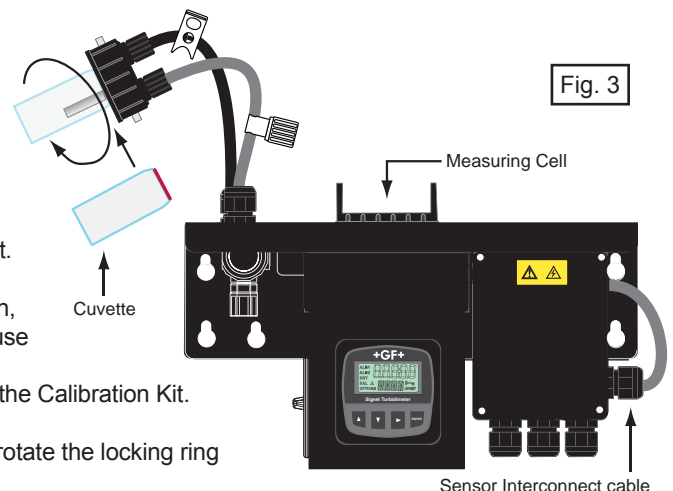
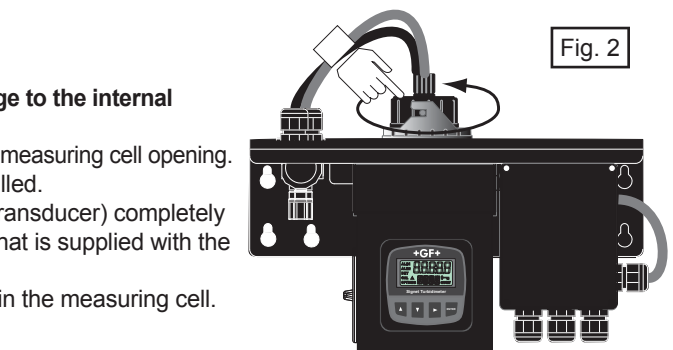

Plumbing

- Use 8 mm (5/16 in.) OD, 5 mm (3/16 in.) ID flexible tubing for the water supply connections.
- Opaque tubing (not supplied) should be used to prevent algae growth if the tubing will be exposed to sunlight.
- The 4150 requires only 1 psi head pressure to operate.
- The flow through cuvette is rated for a flow of 100 mL/m to 1 L/m (0.026 GPM to 0.26 GPM).
- **Inlet water pressure should not exceed 50 psi to avoid damage to the tubing connection to the regulator.**
- **The integral pressure regulator is factory adjusted.**
Do not tamper with the regulator.
- Fluid temperature must not exceed 50 °C (122 °F).
- The shutoff clamp is used to interrupt the flow during cuvette maintenance.
- Route the sensor drain tubing to a suitable drain. Do not reintroduce the drain sample to the process stream.
- Ensure all tubing connections are fitted tightly and no leakages occur.

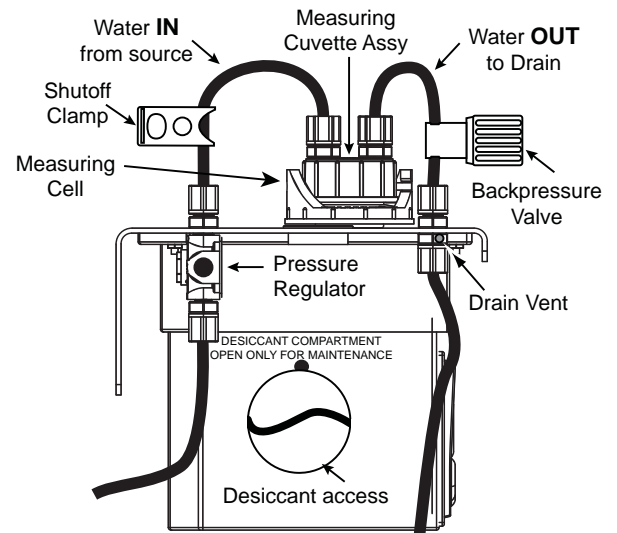

Adjust the Flow to Eliminate Bubbles

The cuvette must be free of air bubbles to provide accurate measurement. The 4150 provides two tools to make this adjustment. Open the SHUTOFF CLAMP to allow water to flow through the cuvette.

1. If the flow is gravity-fed, remove the screw that is blocking the **DRAIN VENT**. This allows for atmospheric equalization and helps to release air from the effluent tube. The vent may leak for a few seconds, until the flow is well established.
 2. Adjust the **BACKPRESSURE VALVE** to prevent air from coming out of solution, which may be observed as tiny air bubbles in the cuvette.
- Remove the measuring cuvette assembly from the measuring cell and place it in the cuvette holder so it is visible while making these adjustments.
 - If bubbles are visible inside the cuvette, turn the BACKPRESSURE VALVE until the bubbles disappear.

If bubbles are still visible inside the cuvette, a Stilling/Bubble Chamber, Signet part number 4150-0003 (159 001 587), can be ordered.



CAUTION:

Risk of damage to the tubing connection.

Do not adjust the pressure regulator.

The tubing connection to the pressure regulator is rated up to 50 psi inlet water pressure.

Contact the factory if inlet pressure will exceed 50 psi. A modified tubing connection may be required.

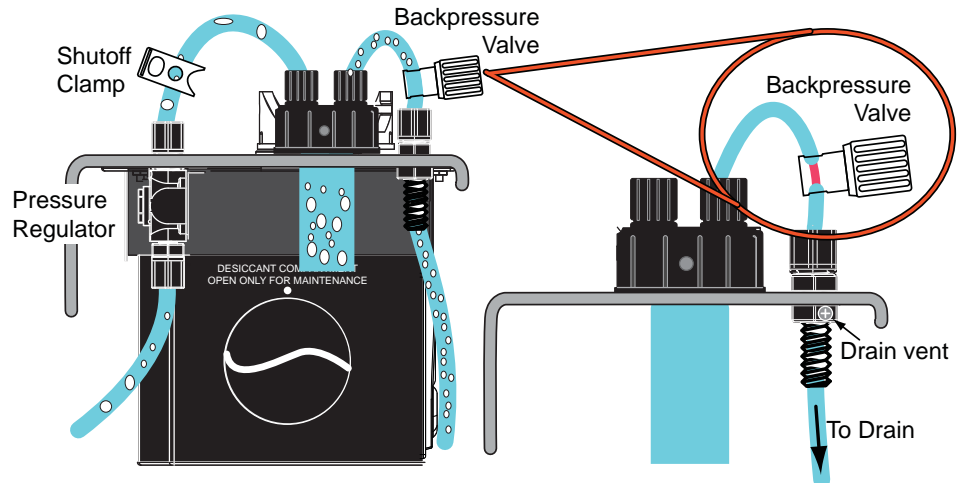

Install the Desiccant Pack: (See Fig. 4)

1. Locate the 3-4150.380 desiccant pack.
2. Remove the desiccant pack from its vacuum-sealed package.
3. Open the desiccant access door by turning it counterclockwise. It is located on the left side of the Turbidimeter.
4. Place the desiccant pack into the instrument's body.
5. Reinstall the access door and rotate clockwise.

NOTE: In regions where moisture or high humidity is prevalent, more than one desiccant pouch may be needed, and desiccant may need to be monitored more often.

Fig. 4

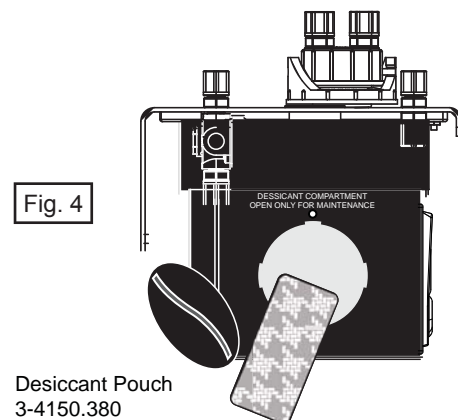

Electrical Connections

All of the electrical connections to the 4150 are made inside the power supply, located to the right of the display.

The connections are labeled within the terminal box and are self-descriptive.

An external grounding terminal is provided for use in the most extreme electrical noise environments. It is not required for most installations.



DANGER:

Risk of injury or death via electrocution.

This instrument requires AC voltages.

- The electrical connection must only be carried out by authorized technical personnel.
- Ensure there is no voltage at the power cord before wiring the instrument.
- Follow all local and government recommendations and methods for installation of electrical connections.



DANGER:

Risk of shock hazard.

Ratings of the instrument will be jeopardized if any of the bulkheads are not tightened properly around a cable or plug.

- Ensure that the watertight seal is maintained after the power supply box has been wired for operation.

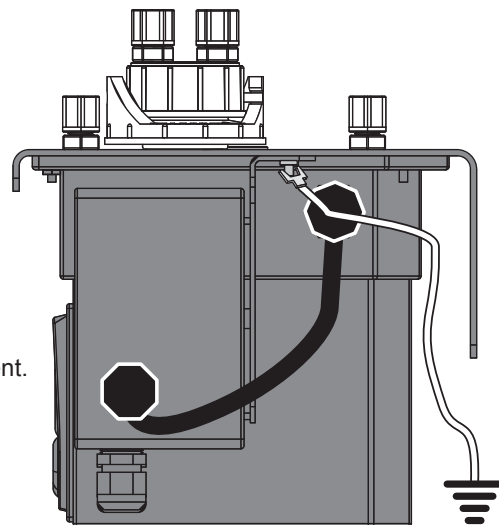

Attach a wire to the small spade lug and connect the housing to a local Earth ground if necessary.



WARNING:

Risk of damage to the instrument or injury.

This instrument is equipped with a 100 to 240 VAC, 47 to 63 Hz switching power supply.

- Ensure that the line voltage falls within these specifications before connecting.
- Install a circuit breaker in the AC line before the 4150 power connection to allow for service.

Power

- The 4150 is not supplied with a power cord.
- The power cable bulkhead will accept cable diameters from 5.8 mm (0.23 in.) up to 10 mm (0.395 in.).
- All terminals are designed to accept wires in the range of 14 to 28 AWG.
- All wires should be stripped to a length of 6 mm (¼ in.).
- A strain relief strap is provided to reduce tension on the AC power terminals.

RS-485

- The RS-485 half-duplex (2-wire) digital interface operates with differential levels that are not susceptible to electrical interferences.
- The last device on each bus requires terminating with a 120 Ω resistor to eliminate signal reflection on the line.
- Do not run RS-485 cables in the same conduit as power.

4 to 20 mA

- The active 4 to 20 mA output is driven by a 15 VDC power source and can drive external loads up to 600 ohms.
- Do not run 4 to 20 mA cables in the same conduit as power.

Relays

Both alarm relays are configured for fail-safe operation. The normal condition is with power applied to the 4150 and in a non-alarm condition.

- The relays are rated for 2 A maximum.
- If power is removed from the 4150, the relays will be in an alarm state.

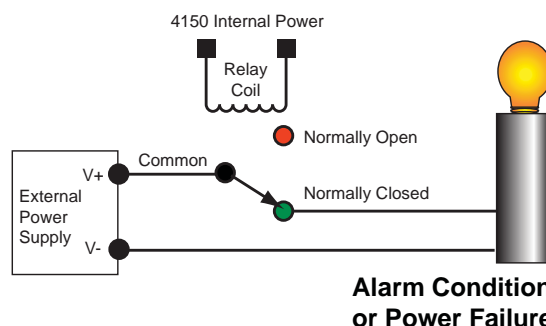
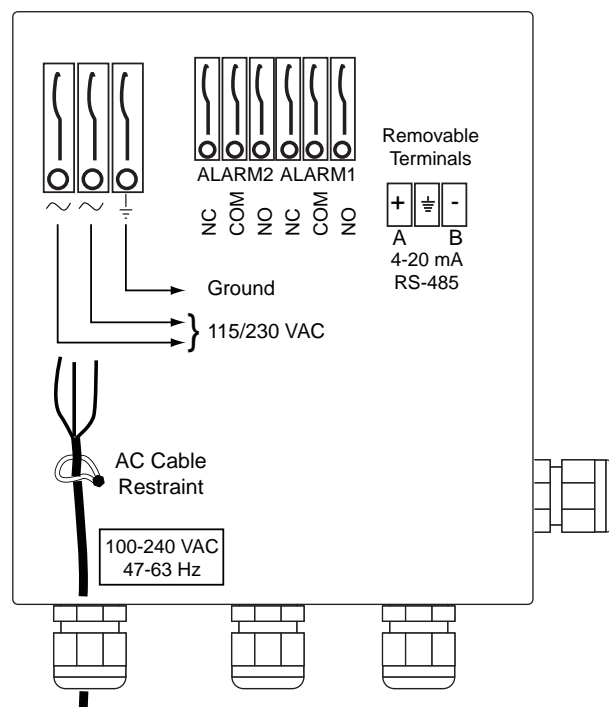
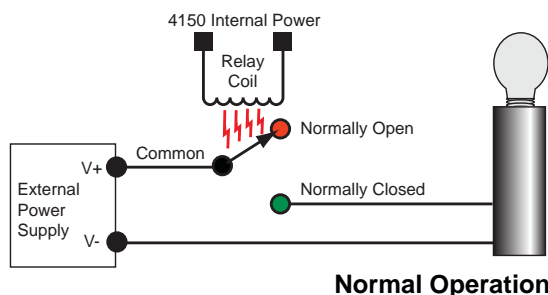

Display Overview

All of the elements on the LCD are identified here:

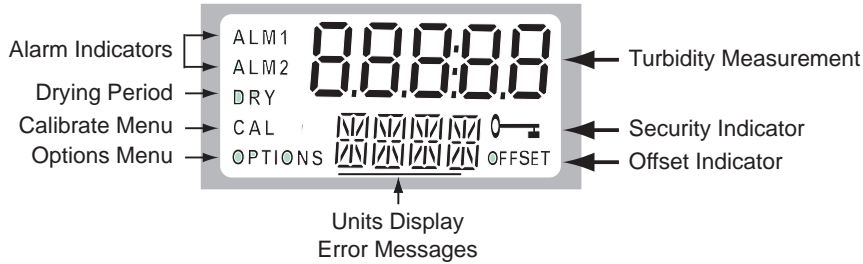

Keypad Overview

Four keys are used to set up, calibrate and operate the 4150.

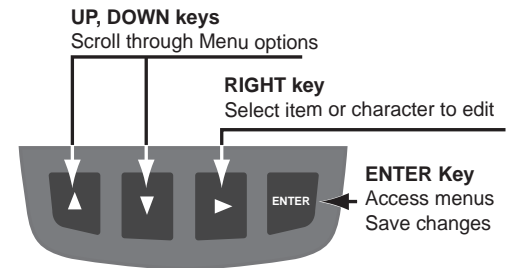

Display Icons and Functions



During normal operation, the instrument will have the Units selection displayed on the lower row of the display and the measured reading on the upper row of the display.

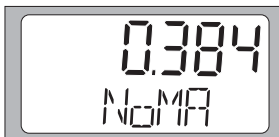

If the unit is set up for 4 to 20 mA output in the Options menu and the circuit is open, the lower NoMA (no mA) display will flash.



If the unit is set up for 4 to 20 mA output in the Options menu and the circuit is closed, pressing ▲ will show the mA current. This display will return to the normal menu after 10 seconds or until ▼ is pressed.



The instrument is equipped with a security access code to protect the instrument settings from inadvertent modification.

If the CODE feature is enabled in the OPTIONS menu, the KEY icon is displayed.



If OFFSET is displayed, the 4150 output has been calibrated to match an external reference measurement.



The ALM1 and ALM2 icons are displayed if the 4150 measurement has exceeded a HIGH or LOW alarm setpoint.



DRY indicates that the 4150 is in a drying period, following the replacement of the cuvette. The internal fan will circulate air to clear condensation from the cuvette.

NOTE: DRY is not an alarm condition. During a DRY period the ultrasonic cleaning system is disabled, but the instrument is still operating.



CAL is displayed when the 4150 is being calibrated.

- The alarm relays are held in their NORMAL condition when CAL is displayed.
- The 4150 will return to normal operation if no keys are pressed in the CAL menu for 15 minutes.

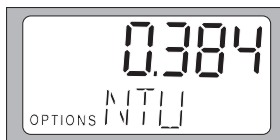

OPTIONS is displayed when the 4150 is being configured.

- The alarm relays are held in their NORMAL condition when OPTIONS is displayed.
- The 4150 will return to normal operation if no keys are pressed in the OPTIONS menu for 10 minutes.

NOTE: Pressing ▲ ► keys together and holding for 10 seconds resets **ALL** instrument parameters back to factory defaults.

Security Feature

If CODE is enabled in the OPTIONS menu, the Access code (▲-▲-▲-▼) must be entered to gain access to CAL or OPTIONS menus.

Access to CALIBRATE Menu

1. Press and hold the ENTER key for 2 seconds



2. Press the ▲ key



3. Press the ▲ key



4. Press the ▲ key



5. Press the ▼ key

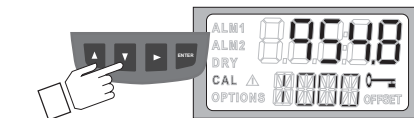

ALM RELAY
is now LOCKED

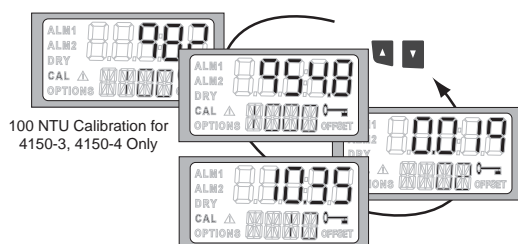

6. Press the ▲ and ▼ keys to select the NTU standard value needed.

Alarm relay contacts are held at the last valid condition while the instrument is in the CALIBRATE or in the OPTIONS menu.

While in the CALIBRATE menu, the instrument has a time-out feature that automatically returns the system to normal operation if no keys are pressed for 15 minutes.

CALIBRATE

The 4150 is tested prior to leaving the factory. Calibration is required before utilizing the 4150.

The EPA recommends that on-line turbidity systems be calibrated at least once every three months if they are used for EPA reporting.

The 4150 is designed to recognize the specific NTU values of certified calibration standards to make periodic recalibration very safe, quick and simple. The CALIBRATE menu is dedicated to this method of calibration.

The OFFSET function found in the OPTIONS menu allows a single-point alignment with an external measurement device.

OFFSET is not a substitute for calibration, but it may be useful if standard solutions are not readily available.

Access to OPTIONS Menu

1. Press and hold the ENTER key for 5 seconds

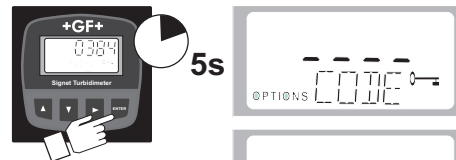

2. Press the ▲ key



3. Press the ▲ key



4. Press the ▲ key



5. Press the ▼ key



ALM RELAY
is now LOCKED

6. Press the ▲ and ▼ keys to select the OPTIONS function that will be modified.

While in the OPTIONS menu, the instrument has a time-out feature that automatically returns the system to normal operation if no keys are pressed for 10 minutes.

Output Options:

Select the 4 to 20 mA output or the RS-485 Digital output.



Alarm 1 Option:

Turn on the 1st ALARM RELAY.



Alarm 2 Option:

Turn on the 2nd ALARM RELAY.



Offset option:

Turn the OFFSET option ON or OFF.



Code option:

Turn the Access Code ON or OFF.



Extended Options:

Display many single-set options like brightness and decimal location. (See OPTIONS: EXTENDED, pg. 19.)

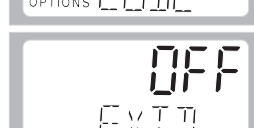

Calibration Standards



The Calibration Standards Kit includes three cuvettes and three pre-mixed calibration standards which are certified to be within the stated accuracy tolerances.

CAUTION:

Calibration standards are temperature sensitive and may contain freezable liquids. Freezing damage voids accuracy.

- For 3-4150-3 and -4 (range 0 to 100 NTU): P/N 3822-4001 (code 159 001 585) Calibration Kit, Turbidity, 100, 10 & 0.02 NTU.
- For 3-4150-1, -2, -5 and -6 (range 0 to 1000 NTU): P/N 3822-4003 (code 159 001 586) Calibration Kit, Turbidity, 1000, 10 & 0.02 NTU.
- A Formazin stock solution kit is also available (P/N 3822-4002). Formazin is very unstable, so it is important to ensure that a fresh stock suspension of Formazin is used to achieve the accuracy quoted for the instrument.
- The non-Formazin calibration standards are much more stable than Formazin and have a shelf life of 12 months.
- If the application is limited to measurements below 10 NTU, such as potable water, a 2-point calibration may be performed using only a 10 NTU and a 0.02 NTU standard.
- If the Signet 4150 Turbidimeter will be used over the entire range, a 3-point calibration is required.
- For best results, index new calibration standard cuvettes to the specific instrument before first use.
- Calibration standards with values of 0.02 NTU and 1000 NTU are supplied in sealed glass cuvettes and are ready to use.
- Calibration standards with values of 10 NTU and 100 NTU are supplied in a 125 ml bottle and must be poured into the empty glass cuvettes included in the Calibration Standards Kit. The 125 ml plastic bottle contains sufficient calibration standard to perform the calibration four times.

IMPORTANT! Calibration does NOT remove OFFSET values.
ALWAYS turn the OFFSET function OFF (Options menu) before performing a full calibration

Calibration Tips

- Keep the measurement cell covered as much as possible during the calibration period.
- Replace the cuvette immediately after the calibration to prevent accelerated saturation of the desiccant.

Preparing 10 and 100 NTU Calibration Standards

The 10 and 100 NTU solution is supplied in a 125 ml bottle and must be poured into the empty cuvettes supplied. Prepare the 10 and 100 NTU solution using the same method outlined below.

1. Pour 5 ml of the 10 or 100 NTU calibration standard into the empty cuvette included in the Calibration Standards Kit.
2. Swirl the calibration standard to cover the entire internal surface of the cuvette and discard.
3. Fill the cuvette with 20 ml of the calibration standard and tighten cap to prevent contamination.
Save the 125 ml plastic bottle with the remaining calibration standard for future use.
4. Mark the cap of the cuvette with the initial pour date of the calibration standard.
5. Use the soft lint-free cloth supplied with the Calibration Standard Kit to clean the outside of the cuvette.
6. Index the calibration standard cuvette as described below.

The solution is now ready to perform a "Primary calibration". Once the "primary" calibration is performed the calibration kit can also be used to verify that the 4150 is still accurate. Use either the 10 or 100 NTU cuvette to perform spot checks on the 4150 in between primary calibrations.

NOTE: The 10 and 100 NTU solution degrades and becomes inaccurate after three months (90 days).

It is important to discard the solution and rinse the cuvettes with mild detergent and DI water prior to replacing the solution. DO NOT USE a bottle brush to clean the cuvette, scratches to the internal surface will alter the optical quality of the glass.

Indexing Calibration Standard Cuvettes

To achieve the greatest accuracy, and compensate for normal scratches and aberrations in cuvette glass when calibrating, index new calibration standard cuvettes to the specific instrument before using the first time. For best results, use the indexing rings supplied with the calibration standard kits.

The following steps allow repeatable indexing of calibration standard cuvettes:

1. With the instrument in normal display mode, remove the measuring cuvette assembly and place it in the cuvette holder.
2. Insert the calibration standard cuvette into the measurement chamber of the 4150 Turbidimeter. Allow a few minutes for the NTU/FNU reading to stabilize.
3. While slowly rotating the calibration standard cuvette inside the optical well one complete revolution (360°), observe the measured turbidity and locate the position of the cuvette having the lowest reading.
4. With the calibration standard cuvette positioned at the location having the lowest turbidity reading, install an indexing ring over the cuvette cap so that the pointer of the indexing ring aligns with the white reference line on the 4150 Turbidimeter.

The calibration standard cuvette is now indexed and ready for use.

Perform this procedure with each calibration standard cuvette.

NOTE: When using the calibration standard cuvette in future or for multiple systems, always insert the cuvette so that the pointer of the indexing ring aligns with the white reference line on the 4150 Turbidimeter. Slowly rotate the calibration standard cuvette back and forth about 5° to locate the position of the cuvette having the lowest reading.

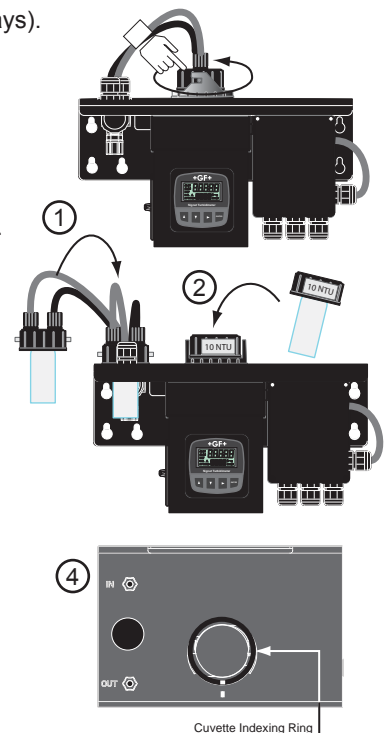

Calibration Procedure



CAUTION:

Risk of impairment of the instrument's performance and damage to the internal electronics of the instrument.

Fluid, moisture, or debris can intrude into the instrument through the measuring cell opening.

- Cover the measuring cell opening while the cuvette is being installed.
- Clean and dry the external surface of the cuvette glass (and transducer) completely from fluid, moisture, or debris with the special cleaning cloth that is supplied with the calibration kit.
- Ensure the cuvette is not leaking fluids before placing it back in the measuring cell.
- Leave the measuring cell open only as long as necessary.

1. **Access the Calibrate menu by pressing the ENTER key for 2 seconds.**
2. **Enter the access security code if necessary. (See pg. 8.)**
 - CAL will be illuminated on the display.
 - The upper display will show the measured NTU value.
 - The lower display will alternate the value of the first NTU standard and -- -- }.
3. **Remove the measuring cuvette assembly and place it in the cuvette holder.**

NOTE: Use the special cleaning cloth that comes with the calibration kit when handling the cuvette in order to avoid scratching or marking the glass surface of the cuvette. Substances on the surface of the glass will cause errors in the measurement.

NOTE: Removing the cuvette will cause the cleaning cycle to be interrupted for 30 minutes to allow the desiccant time to remove any introduced moisture.

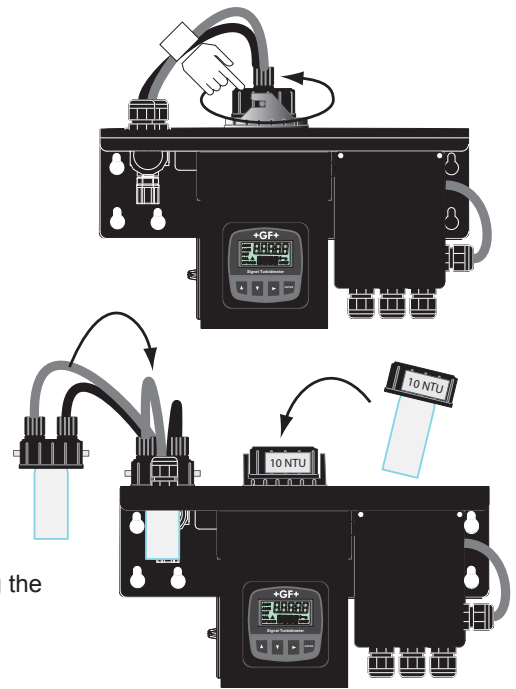

4. Insert the first calibration standard cuvette requested by the 4150.

The first NTU standard requested will be either 1000 or 100, depending on the range of your 4150. In this example it is 1000. If the application will be limited to low turbidity values (less than 10 NTU), press the ▼ key to go to the 10 NTU calibration.

NOTE: 10 and 100 NTU solution must be replaced every three months and the glass cuvette must be cleaned properly.

- Align the pointer of the indexing ring with the white reference line on the 4150 Turbidimeter. Slowly rotate the calibration standard cuvette back and forth about 5° to locate the position of the cuvette having the lowest reading.
- Press the ► key. The 4150 will begin the calibration process. The upper display will count down the progress. When the process is complete, the upper display shows the new NTU value, while the lower display alternates the value of the NTU standard and -- -- }.

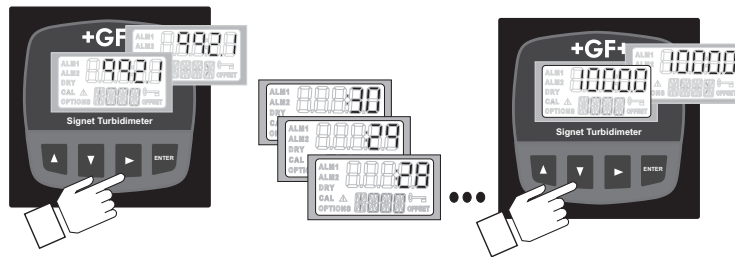

- Press the ▼ key. The lower display will show the next NTU Standard value and -- -- }.

5. Insert the 10 NTU calibration standard cuvette.

- Align the pointer of the indexing ring with the white reference line on the 4150 Turbidimeter. Slowly rotate the calibration standard cuvette back and forth about 5° to locate the position of the cuvette having the lowest reading.
- Press the ► key. The 4150 will begin the calibration process. Be sure the lower CAL number corresponds to the second calibration standard you are using. In this example it is 10. The upper display will count down the progress. When the process is complete, the upper display shows the new NTU value, while the lower display alternates the value of the NTU standard and -- -- }.

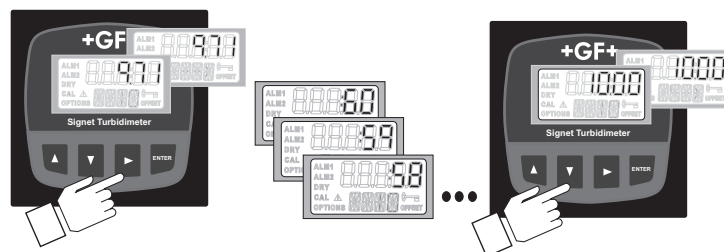

- Press the ▼ key. The lower display will show the next NTU Standard value and -- -- }.

Calibration Procedure

6. Insert the 0.02 NTU calibration standard cuvette.

- Align the pointer of the indexing ring with the white reference line on the 4150 Turbidimeter. Slowly rotate the calibration standard cuvette back and forth about 5° to locate the position of the cuvette having the lowest reading.
- Press the ► key. The 4150 will begin the calibration process. Be sure the lower CAL number corresponds to the third calibration standard you are using. In this example it is 0.02. The upper display will count down the progress. When the process is complete, the upper display shows the new NTU value, while the lower display alternates the value of the NTU standard and -- -- ↵.

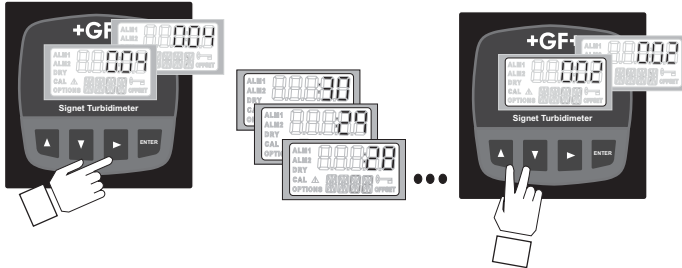

When calibration is complete, press the ▲ and ▼ keys together to exit the CAL menu and return to normal operation.



Calibration Error

If the 4150 displays Error after calibration, the calibration standards were out of calibration range, or the standard did not match the NTU value being requested by the 4150. **The instrument cannot be used until the error is resolved.**



1. Check the standards and recalibrate:
 - Press and hold the ENTER key for 2 seconds and start the calibration sequence again.
2. To restore only the factory calibration:
 - Press and hold the ▲ key for 3 seconds until the display changes.

IMPORTANT!

This action will reset the **CALIBRATE** settings back to factory default (00.00 NTUs). The **OPTION** settings will not be changed.

Operating Tip:

Use the 10 and 100 NTU cuvette daily to spot check the accuracy of the 4150. This eliminates the use of a hand-held device and reduces the amount of time to verify the accuracy of the 4150.

NOTE: Replace the 10 and 100 NTU solutions after three months of use (90 days).

OPTIONS Menu

The OPTIONS menu contains settings that are generally set once then rarely changed. The factory setting for all the items in the OPTIONS menu is OFF. When an option is turned ON, settings related to that option will appear in the menu.

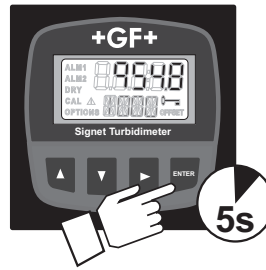

Press and hold the ENTER key until OPTIONS is illuminated on the display. Enter the ACCESS CODE if the key is displayed.

<p>OPTIONS O/P</p>	<p>Output Options: Select 4–20 mA output (O/P), RS-485 digital output or OFF.</p>
<p>OPTIONS ALM1</p>	<p>Alarm 1 Option: Turn ALARM RELAY 1 ON or OFF.</p>
<p>OPTIONS ALM2</p>	<p>Alarm 2 Option: Turn ALARM RELAY 2 ON or OFF.</p>
<p>OPTIONS OFST</p>	<p>Offset Option: Turn the OFFSET option ON or OFF.</p>
<p>OPTIONS CODE</p>	<p>Code option: Turn the Access Code ON or OFF.</p>
<p>OPTIONS EXT0</p>	<p>Extended Options: Enable access to performance and setup options like brightness and decimal location. (See OPTIONS: EXTENDED, pg. 19)</p>

OPTIONS: Output (O/P)

1. The lower display should show O/P. If it does not, Push the ▼ key until the lower display shows O/P.
2. Press the ► key. The upper display will begin blinking.
3. Press the ▲ or ▼ keys to scroll to the 4 to 20 mA output, the RS-485 Output or OFF.
4. Press the ENTER key to save the selection.

Configuring the 4 to 20 mA Output

1. Press the ▼ key. The lower display shows 4 mA.
2. Press the ► key. The upper display will begin blinking.
3. Press the ▲ and ▼ keys to scroll to the NTU/FNU value at 4 mA.
4. Press the ENTER key to save the setting.
5. Press the ▼ key. The lower display shows 20 mA.
6. Press the ► key. The upper display will begin blinking.
7. Press the ▲ and ▼ keys to scroll to the NTU/FNU value at 20 mA.
8. Press the ▼ key. The lower display shows ERLV (Error Level).
Choose 2 mA, 4 mA, 0 mA, or OFF. This is an mA value that the 4150 will generate if there is a system failure.
9. Press the ENTER key to save the setting.

Press the ▲ and ▼ keys simultaneously to exit the OPTIONS menu and return to normal operation.

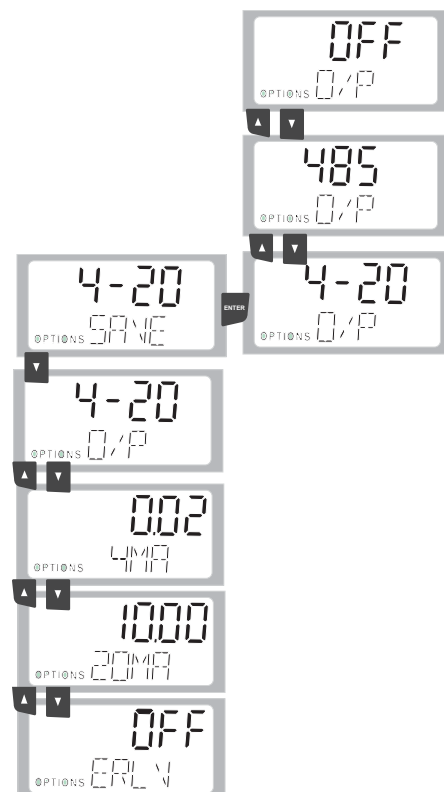

Configuring the RS-485 Output

1. Press the ▼ key. The lower display shows BAUD.
2. Press the ► key. The upper display will begin blinking.
3. Press the ▲ and ▼ keys to scroll to the baud rate required (1200, 2400, 4800, 9600, or 19200)
4. Press the ENTER key to save the setting.
5. Press the ▼ key. The lower display shows ADDR (Address).
6. Press the ► key. The upper display will begin blinking.
7. Press the ▲ and ▼ keys to scroll to the correct address. Address options are from 1 to 255.
8. Press the ENTER key to save the setting.
9. Press the ▼ key. The lower display shows MBUS.
10. Press the ► key. The upper display will begin blinking.
11. Press the ▲ and ▼ keys to select ASCII or RTU.
12. Press the ENTER key to save the setting.

Press the ▲ and ▼ keys simultaneously to exit the OPTIONS menu and return to normal operation.

RS-485 Default Settings

RS-485 must be selected in order to access this menu function.

The setting of 8 bits, 1 stop bit and no parity are set as default for the RS-485 port. To change these settings, enable the Extended Options menu and scroll down the Extended Options to the menus seen below.

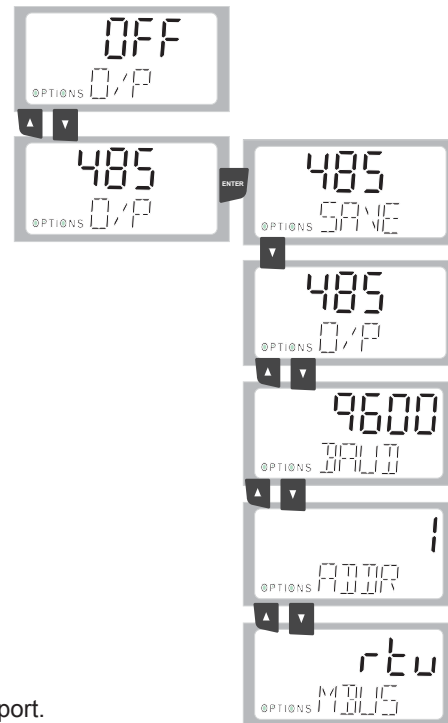

Modbus Serial Communication Protocol

Modbus is a communication protocol based on a multidrop Master/Slave architecture. This technique supports a network of up to 255 slave devices with each device given a unique address.

The transmission protocol used in the 4150 is RS-485, with the unit operating as a slave to a master Modbus device.

The 4150 has two transmission modes: Either ASCII (American Standard Code for Information Interchange) or RTU (Remote Terminal Unit).

To prevent damage to the instrument, be sure that the 4150 is not powered when connecting the RS-485 line.

Modbus RS-485 Output and Commands

If the connection is to the master on a RS-232 serial port, an RS-232 to RS-485 converter is required.
If the connection to the master is USB, an RS-485 to USB converter is required.

Coils

These single-bit values are readable and changeable from the master.
The data will be returned with the lowest addressed coil in the LSB of the data.
Unused bits in the data will be set to 0.
True is 1 and False is 0.

Valid Command(s)

Code	Name	Broadcast
0x01	Read Coil Status	No
0X05	Force Single Coil	Yes

Format

16-bit word format

MSB															LSB
Bit 15	Bit 14	Bit 13	Bit 12	Bit 11	Bit 10	Bit 9	Bit 8	Bit 7	Bit 6	Bit 5	Bit 4	Bit 3	Bit 2	Bit 1	Bit 0

Valid Addresses

0001–00XXX

Definitions

Address	Function	Default
00001	Offset added	False
00002	Flow alarm selected	False
00003	Access code enabled	False
00004	Ultrasonic cleaning enabled (if available)	True
00005	Desiccant set as error (True) or warnings (False)	True

Input Status

These single-bit values are readable from the master.
The data will be returned with the lowest addressed input status in the LSB of the data.
Unused bits in the data will be set to 0.

Valid Command(s)

Code	Name	Broadcast
0x02	Read Input Status	No

Format

16-bit word format

MSB															LSB
Bit 15	Bit 14	Bit 13	Bit 12	Bit 11	Bit 10	Bit 9	Bit 8	Bit 7	Bit 6	Bit 5	Bit 4	Bit 3	Bit 2	Bit 1	Bit 0

Valid Addresses

10001–10XXX

Definitions

Address	Function
10001	Instrument error
10002	Alarm 1 active
10003	Alarm 2 active
10004	Calibration error
10005	Desiccant error

Holding Registers

These 16-bit values are readable and changeable from the master.
The data is stored and transmitted with the MSB first and then the LSB.

Valid Command(s)

Code	Name	Broadcast
0x03	Read Holding Registers	No
0x06	Preset Single Register	Yes
0x16	Preset Multiple Registers	Yes

Format

Float: This is stored in two consecutive addresses, with the first address containing the least significant word (lower part of mantissa) and the second address containing the most significant word (sign, exponent, and upper part of mantissa).

Definitions

Address	Type	Register	Value	Default	Function
40001, 40002	Float	Offset value	--	0.0	0.0 – 2.0
40003	Int	Decimal places	0	2	XXXXX.
			1		XXXX.X
			2		XXX.XX
			3		XX.XXX
			4		X.XXXX
40004	Int	Response time	--	10	1–100 seconds
40005	Int	LCD backlight	--	8	1–10 (brightest)
40006	Int	Output option	0	0	None
			1		4 to 20 mA
			2		RS-485 (if available)
40007, 40008	Float	4 to 20 mA minimum value	--	0.02	0.0 to max range of instrument
40009, 40010	Float	4 to 20 mA maximum value	--	10.0	0.0 to max range of instrument
40011	Int	RS-485 baud rate	0	3	1,200
			1		2,400
			2		4,800
			3		9,600
			4		19,200
40012	Int	Instrument address	--	1	1–255
40013	Int	Modbus serial mode	0	0	RTU
			1		ASCII
40014	Int	Alarm 1 type	0	0	Off
			1		Low alarm
			2		High alarm
40015, 40016	Float	Alarm 1 set point	--	1.0	0.0 to max range of instrument
40017	Int	Alarm 1 delay on	--	1	1–30 seconds
40018	Int	Alarm 1 delay off	--	1	1–30 seconds
40019	Int	Alarm 2 type	0	0	Off
			1		Low alarm
			2		High alarm
40020	Int	Not used	--		
40021, 40022	Float	Alarm 2 set point	--	1.0	0.0 to max range of instrument
40023	Int	Alarm 2 delay on	--	1	1–30 seconds
40024	Int	Alarm 2 delay off	1	1	1–30 seconds
40025	Int	Units (scaling)	1	1	NTU
			2		FNU

Valid Addresses

40001 – 40XXX

Input Registers

These 16-bit values are readable by the master. The data is stored with the MSB first and then the LSB.

Valid Command(s)

Code	Name	Broadcast
0x04	Read Input Registers	No

Format

Float: This is stored in two consecutive addresses, with the first address containing the least significant word (lower part of mantissa) and the second address containing the most significant word (sign, exponent, and upper part of mantissa).

Definitions

Address	Type	Register	Value	Function
30001, 30002	Float	Sensor reading	--	The meter reading
30003, 30004	Float	Sensor reading raw	--	Sensor reading to six significant places
30005	Int	Version major	--	Software version major number
30006	Int	Version minor	--	Software version minor number
30007	Int	Version revision	--	Software version revision number
30008	Int	Model number	--	Product number
30009	Int	Model suffix number	--	0 if no options
30010	Int	Reading status	1	normal
			2	over range
			3	under range
			6	reading problem
30011	Int	Instrument error summary (bit-mapped)	0x0000	Normal
			0x0001	Error
			0x0002	Alarm 1 is active
			0x0004	Alarm 2 is active
			0x0008	Calibration error
30012	Int	Errors (bit-mapped)	0x0000	Normal
			0x0001	Replace desiccant
			0x0002	Break in the 4 to 20 mA
			0x0004	Calibration error
			0x0010	Data over-range
			0x0020	Flow switch alarm
			0x0040	Lamp problem
			0x0080	Auto-cleaning problem
			0x0100	General error
			0x0200	General error
			0x0400	General error
30013	Int	PCB Revision	0	Revision 1
			1	Revision 2

Valid Addresses

30001 – 30XXX

Exception Responses Implemented

Code	Name	Meaning
00	--	No error
01	ILLEGAL FUNCTION	The function code is not allowed in the device.
02	ILLEGAL DATA ADDRESS	The data address is not allowed in the device
03	ILLEGAL DATA VALUE	A value contained in the query field is wrong for the device

Options: Alarm Relays

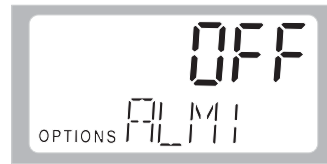

Options: Alarm Relays (ALM)

The 4150 has two relays that can be programmed to serve as High, Low or Error alarms. The relays are factory set to OFF. When activated, and the mode is set to either High or Low, each relay can be programmed with a Setpoint (S/P), a Delay ON time and a Delay OFF time.

1. Press the ▼ key to scroll to the ALM1 display.
 2. Press the ► key to begin programming Alarm #1. The upper display begins blinking.
 3. Press the ▲ and ▼ keys to select Off, Error, Hi or Lo operating mode for this relay. Press the ENTER key to save the setting. The Error setting allows the alarm to trigger if there are the following errors:
 - DESC - See Vapor Purge (pg. 20)
 - CLN - See Ultrasonic Cleaning (pg. 21)
 - NoMA - See Display Overview (pg. 7)
 - Any system failure
 4. Press the ▼ key. The lower display shows S/P (Set Point). The ALM1 or ALM2 icons will be displayed to indicate which relay is being set. Press the ► key. The upper display begins blinking. Press the ▲ and ▼ keys to scroll to the NTU value where the Alarm will be activated. Press the ENTER key to save the setting. Press the ▼ key to scroll to the next menu item.
 5. Press the ▼ key. The lower display shows DLY ▲ (Delay ON time). Press the ► key. The upper display begins blinking. Press the ▲ and ▼ keys to scroll to the time (from 1 second to 30 seconds) before the Alarm relay will be activated. Press the ENTER key to save the setting. Press the ▼ key to scroll to the next menu item.
 6. Press the ▼ key. The lower display shows DLY ▼ (Delay OFF time). Press the ► key. The upper display begins blinking. Press the ▲ and ▼ keys to scroll to the time (from 1 second to 30 seconds) before the Alarm relay will be deactivated. Press the ENTER key to save the setting.
- Press the ▼ key again to go to ALM2 display.
Press the ► key to begin programming ALM2. The upper display begins blinking. Repeat steps 3 through 6.

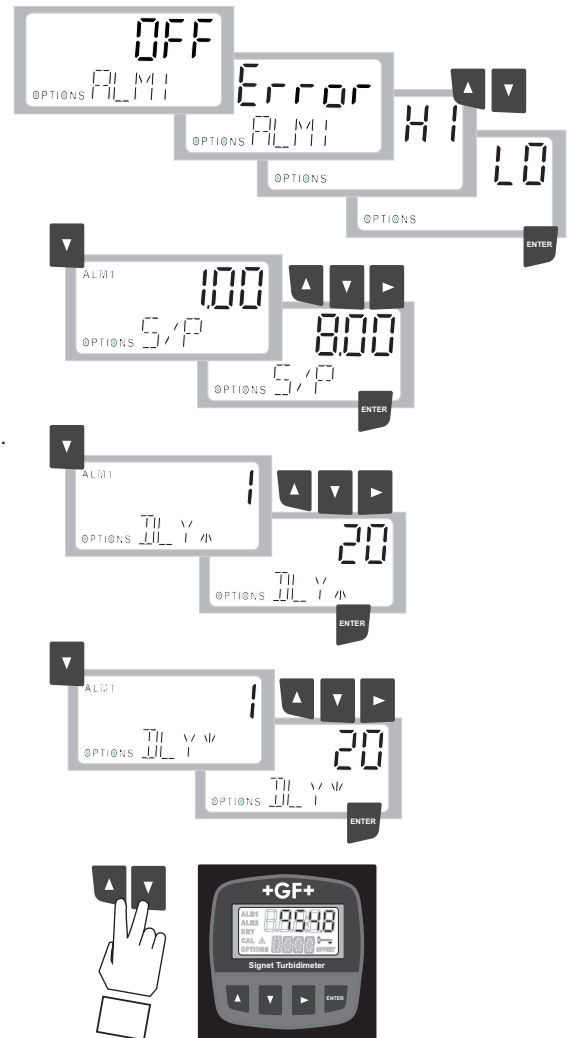

Press the ▲ and ▼ keys simultaneously to exit the OPTIONS menu and return to normal operation.

Options: Instrument Offset



Options: Instrument Offset (OFST)

The OFFSET function allows the 4150 to be calibrated to match a process grab sample.

This procedure is not recommended in lieu of regular instrument calibration.

This function is only useful at turbidity levels in the immediate vicinity of the grab sample and not in the full range of the instrument.

The OFFSET icon is illuminated in the normal display whenever an offset is applied.

The maximum offset is ± 1.00 NTU.

If the 4150 varies from the sample by more than 1 NTU a full calibration is required.

IMPORTANT! Offset values will remain in the memory even after a complete calibration.

ALWAYS turn the OFFSET function OFF (Options menu) before performing a full calibration with the calibration standards.

1. Using a handheld device, take a sample of the water from the same source as the 4150.
2. Test according to manufacturers instructions.
3. Compare the turbidity reported by the 4150 to the handheld meter. Subtract that value from the 4150 value.

Example:

Laboratory sample measures 4.20 NTU, while the 4150 reads 4.50 NTU, or 0.3 NTU high. The OFFSET needs to be set to -0.3

1. Press and hold the ENTER key until OPTIONS is illuminated on the display.
2. Push the ▼ key until OFST is displayed on the lower row.
3. If the upper display says ON, go to step 4.

If the upper display says OFF:

- Press the ► key and then ▼ to turn the OFFSET function ON.
- Press the ENTER key to save the change.
- Press the ▼ key to display the OFFSET value in the upper display.

4. Press the ► key. The upper display will begin blinking.

5. If the OFFSET value is a POSITIVE number, press the ▲ key to scroll to a positive offset value.

If the OFFSET value is a NEGATIVE number, press the ▼ key to scroll to a negative offset value.



Scroll UP for positive Offset.



Scroll DOWN for negative Offset.

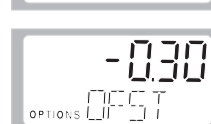
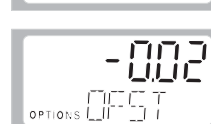

Options: Extended



Options: Extended Options (EXTD) The EXTENDED menu contains many single-set options and will always revert to OFF when you exit the menu.

OPTIONS: Extended: Response Time

The response time determines how quickly the 4150 responds to changes in the NTU measurement. 1 = approx. 5 seconds, 100 = approx. 500 s. Select a high value to avoid reading air and other anomalies. Select a low value to react to rapid changes in the measurement. Set the response time using the ▲ and ▼ keys. Press the ENTER key to save the new setting.

OPTIONS: Extended: Display Resolution

The 4150 can display up to four decimal places. The factory setting is 0.01. Set the resolution by pressing the ▲ or ▼ keys. Press ENTER key to save the selection.

OPTIONS: Extended: LCD Backlight Brightness

The LCD backlight brightness can be adjusted. Ten levels are available. The default brightness is 8. Set the brightness by pressing the ▲ or ▼ keys. Press ENTER key to save the selection.

OPTIONS: Extended: Units

All instruments are shipped from the factory set in NTU mode. The 4150 can also display in FNU (Formazin Nephelometric Units). Use the ▲ and ▼ keys to change to FNU. Press ENTER key to save the selection.

OPTIONS: Extended: Ultrasonic Cleaning (3-4150-3, -4, -5, -6 models)

The default mode is On. Unit will stay in CLN mode unless turned off. Use the ▲ and ▼ keys to turn OFF. Press the ENTER key to save the selection.

OPTIONS: Extended: RS-485 Parameters

These three menus will only appear if the RS-485 is selected as the OUTPUT option. Factory settings are:

Make selections using the ▲ and ▼ keys.
Press the ENTER key to save the selection

8 Bits

No (nOnE) Parity

1 Stop Bit

OPTIONS: Extended: Desiccant Alarm

Turn ON to activate the alarms when the humidity detector indicates that the internal environment is close to the point where humidity could cause condensation. The 4 to 20 mA output will then fall to the ERLV value you set in the 4 to 20 mA output settings in the OPTIONS menu (pg. 12, item 8).

OPTIONS: Extended: Adjust 4 mA

Applies a ± 10% offset from 4 mA. Units are in microamps (µA). 100 microamps = 0.1 mA. Maximum adjustable limit is 3.6 mA to 4.4 mA (± 400 µA).

OPTIONS: Extended: Adjust 20 mA

Applies a ± 10% offset from 20 mA. Units are in microamps (µA). 100 microamps = 0.1 mA. Maximum adjustable limit is 18 mA to 22 mA (± 2000 µA).

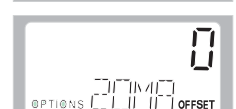
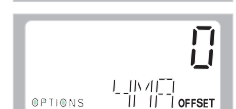

Vapor Purge System

If the air inside the 4150 is too humid it will cloud the optical glass cuvette surface and will interfere with the transmission of light.

A continuous vapor purge system in the 4150 keeps the inside of the instrument dry.

- The air inside the unit is dried by a replaceable desiccant pouch (order number 3-4150.380) located under the measuring cell.
- System heat is used to warm the air.
- A fan inside the instrument continuously circulates heated dry air around the measuring cell and the flow-through cuvette.
- A humidity detector in the 4150 continuously monitors the desiccant condition. When the internal environment approaches the point where condensation may occur, the instrument will display DESC as a warning.
- The DESC warning does not interrupt the operation of the 4150, but the cause of the high condensation must be checked.
- If DESC ALARM is turned on (see OPTIONS: EXTENDED on pg. 19), any active relay will go into alarm condition (if set up in the OPTIONS menu) and the 4 to 20 mA output will be locked to the ERLV (Error Level) value you set in the 4 to 20 mA output configuration in the OPTIONS menu (pg. 12): OFF, 0 mA, 2 mA or 4 mA. Factory default is OFF.



Replacing Desiccant



CAUTION:

Risk of impairment of the instrument's performance and damage to the internal electronics of the instrument.

The desiccant's shelf life degrades once exposed to the atmosphere.

- Remove the desiccant from the packaging just before installation.
 - Close the access door to the desiccant compartment quickly after installation.
 - Replace the desiccant when the instrument displays DESC as a warning or when the desiccant is saturated.
 - Ensure access door to the desiccant compartment seals properly.
 - DO NOT DRY AND REUSE THE DESICCANT.
- To install or remove the desiccant pouch, open the round port on the side of the 4150.
 - Open the protective packaging of the desiccant and place the desiccant inside the instrument.
 - Close the access door quickly to minimize exposing the desiccant to the atmosphere.

Operating Tip

- To speed up recovery after a DESC alarm, disconnect the sensor interconnect cable (connector on the right side of the Turbidimeter power supply) for 2 seconds and then reconnect it.
- Order spare desiccant pouches to keep on the shelf.

NOTE: In regions where moisture or high humidity is prevalent, more than one desiccant pouch may be placed in the instrument, and desiccant may need to be monitored more often.

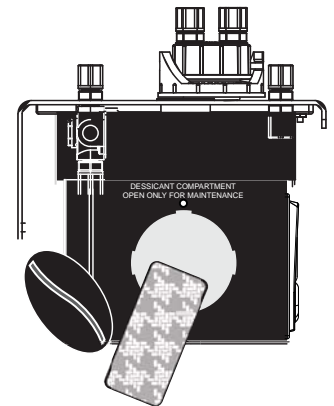

Desiccant Pouch
3-4150.380

Cleaning the Flow-Through Cuvette



CAUTION:

Risk of impairment of the instrument's performance and damage to the internal electronics of the instrument.

Fluid, moisture, or debris can intrude into the instrument through the measuring cell opening.

- Move the cuvette away from the measuring cell opening and cover the measuring cell while the cuvette is being serviced.
- Clean and dry the external surface of the cuvette glass (and transducer) completely from fluid, moisture, or debris with the special cleaning cloth that is supplied with the calibration kit.
- Ensure the cuvette is not leaking fluids before placing it back in the measuring cell.
- Leave the measuring cell open only as long as necessary.

All glass cuvettes must be clean and free of marks or scratches.

- Clean the interior and exterior with a detergent solution and then rinse several times with distilled or deionized water.



CAUTION:

Do not use a bottle brush to clean the cuvette. Scratches will alter the optical quality of the glass.

To replace a cuvette:

- Shut off the flow using the shutoff clamp.
- Unscrew the old cuvette and replace with a fresh clean one.
- Do not touch the glass surface of the cuvette. Fingerprints can compromise the accuracy of the measurement.

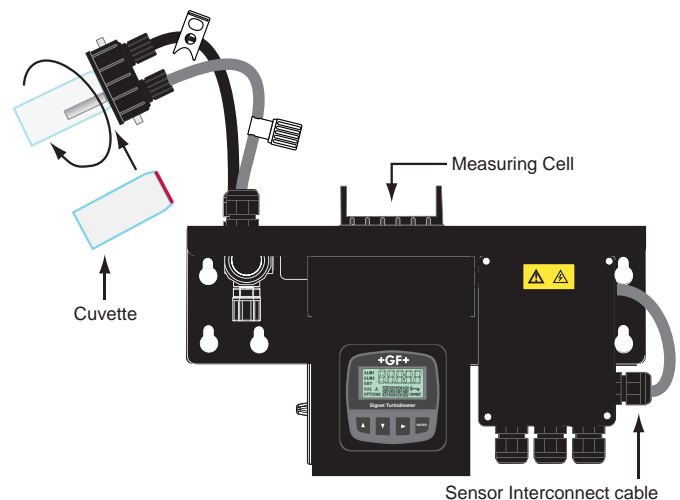

Ultrasonic Cleaning



CAUTION:

Risk of impairment of the instrument's performance and damage to the internal electronics of the instrument (and transducer).

Fluid, moisture, or debris can intrude into the instrument through the measuring cell opening.

- Move the cuvette away from the measuring cell opening and cover the measuring cell while the cuvette is being serviced.
- Clean and dry the external surface of the cuvette glass (and transducer) completely from fluid, moisture, or debris with the special cleaning cloth that is supplied with the calibration kit.
- Ensure the cuvette is not leaking fluids before placing it back in the measuring cell.
- Leave the measuring cell open only as long as necessary.

- The 3-4150-3, 3-4150-4, 3-4150-5 and 3-4150-6 feature a special flow-through cuvette with an ultrasonic piezo attached to the base. Spring contacts inside the cuvette housing send a high frequency signal to the piezo transducer. The vibration helps prevent scaling and other suspended solids in the process water from adhering to the inside surface of the optical glass.
- The ultrasonic system is not intended to clean dirty cuvettes, or to replace manual cleaning entirely, but it will dramatically increase the time between cleaning.



Flow-through Cuvette with Ultrasonic Transducer (4150-0004)

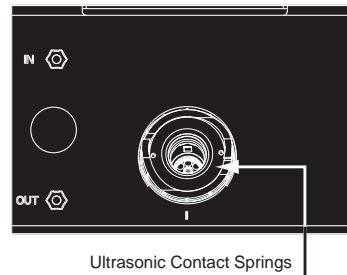

Ultrasonic cleaning feature in 3-4150-3, 3-4150-4, 3-4150-5 and 3-4150-6 only.

Ultrasonic Contact Springs

- The 4150 will show CLN on the lower display if a problem is detected with the cuvette:
 - Incorrect cuvette installed.
 - No contact between cuvette piezo and springs.



- CLN is an alarm condition. Any active relay will be set to alarm state (if set up in the OPTIONS menu) and the 4 to 20 mA will be locked to the ERLV (Error Level) value you set in the 4 to 20 mA output configuration in the OPTIONS menu (pg. 12): OFF, 0 mA, 2 mA or 4 mA. Factory default is OFF.
- After installing a cuvette, the 4150 will show DRY on the lower display for 30 minutes. During this time, the ultrasonic circuit will not operate to allow the Vapor Purge system to remove all moisture from the ultrasonic transducer.
- The Vapor Purge system will NOT remove large droplets of water, only residual moisture. The DRY message is normal and is not considered an alarm condition, therefore no alarms will be implemented. If the cuvette is removed during this period no CLN alarm is posted until the 30-minute DRY period times out.

Troubleshooting

Signet 4150 Fault Detection

The Signet 4150 performs continuous diagnostic monitoring. There are three levels of fault detection: warnings, errors and failures.

Warning

A warning is simply a screen indication of a problem. The measurement is not interrupted and no alarms are activated.

- When the desiccant becomes saturated, a screen warning of **DESC** will appear.

Error

An error indicates a failure or a problem that usually can be corrected. These errors include:

- (**MA**): 4 to 20 mA loop open
- (**CAL**): Bad calibration
- (**DESC**): Desiccant alarm activated and replacement required
- (**CLN**): Ultrasonic transducer is not making contact or the flow through cuvette has been removed
- (**LAMP**): Lamp out. The source lamps in the Signet 4150 are designed for long life

Replacing the lamp involves significant disassembly and handling delicate components.

We recommend returning the unit to the factory for this service. If field replacement is required, contact the factory for assistance.

If any of these conditions occurs, both relays will be set to the alarm state and the 4 to 20 mA output be held at the Error Level (ERLV) selected in the Options Menu (if 4 to 20 mA is selected).

System FAIL Message

A failure is a system fault. This is NOT a problem that the operator can correct, and the unit must be returned to the factory for service.

If a failure occurs, the instrument will not function properly and will display the word **FAIL** on the lower row. Both alarm relays will be activated and the 4 to 20 mA output will be held at the Error Level (ERLV) selected in the Options Menu (if 4 to 20 mA is selected).

Symptom	Possible Cause	Solution
Lower display shows NoMA	4 to 20 mA open loop warning when 4 to 20 mA is enabled in Options Menu	Check Loop wiring or turn off in Options Menu.
Lower display shows DESC	High condensation	Check for leaks or replace desiccant pouch.
Lower display shows LAMP	Lamp failed	Contact factory for assistance.
Lower display shows FAIL	Major system fault	Return to factory for service.
Readings are higher than expected	Bubbles in solution	Ensure that the drain vent is open and is not obstructed. Apply back pressure. Install an optional Stilling/Bubble Chamber (4150-0003, 159 001 587).
	Condensation or leaky cuvette	Check flow through cuvette for condensation or leaks.
	Flow-through cuvette dirty	Clean cuvette
	Instrument out of calibration	Recalibrate
Readings are erratic	Bubbles in solution	Ensure that the drain vent is open and is not obstructed. Apply back pressure. Install an optional Stilling/Bubble Chamber (4150-0003, 159 001 587).
	Debris in flow-through cuvette	Clean debris from cuvette.
Readings are lower than expected	Instrument out of calibration	Recalibrate
Display shows "Err CAL"	Calibration error or bad standard used	Press the up key to recalibrate (see calibration) or replace the standard.
Upper display flashes	Sample Over-Range	Check sample. Sample may be too high to read.
10 NTU Calibration Standard reading out of tolerance	Calibration Standard(s) may have frozen (all standards in kit may be affected).	Replace Calibration Standard Kit. Verify Calibration Standard Kits are stored above 0 °C (32 °F), contents are temperature sensitive.

NOTE: Repairs not described in this manual may only be carried out at the manufacturer or by the service organization.

Ordering Information

Part Number	Code	Description
3-4150-1	159 001 596	Turbidimeter, White Light, 0 to 1000 NTU/FNU
3-4150-2	159 001 597	Turbidimeter, Infrared, 0 to 1000 NTU/FNU
3-4150-3	159 001 598	Turbidimeter, White Light, 0 to 100 NTU /FNU With AutoClean
3-4150-4	159 001 599	Turbidimeter, Infrared, 0 to 100 NTU/FNU With AutoClean
3-4150-5	159 001 600	Turbidimeter, White Light, 0 to 1000 NTU/FNU With AutoClean
3-4150-6	159 001 601	Turbidimeter, Infrared, 0 to 1000 NTU/FNU With AutoClean

Replacement Parts

4150-0001	159 001 593	Pressure Regulator
4150-0003	159 001 587	Stilling/Bubble Chamber
4150-0004	159 001 589	Replacement cuvette with ultrasonic transducer
4150-0005	159 001 595	Tubing Kit: 1-shutoff clamp, 1-backpressure valve, 2-connecting tubing with fittings, 1-drain vent
4150-0007	159 001 602	Replacement cuvette set (3 glass cuvettes)
4150-0028	150 301 006	**Cuvette Caps (Special Order Only)
3-4150.380	159 001 588	Replacement Desiccant
3-4150.381	159 001 613	**Replacement Desiccant cap with gasket (Special Order Only)
3-4150.382	159 001 650	**Turbidity Lamp Replacement Kit, White Light
3-4150.383	n/a	**Turbidity Lamp Replacement Kit, Infrared
3-4150.386	159 001 652	O-ring replacement kit for cuvette
3-4150-24V	159 001 723	**24 Volt Power Supply (Special Order Only)

Calibration Accessories

3822-4000	159 001 592	*Formazin Stock Solution, 4000 NTU/FNU, 500 ml
3822-4002	159 001 591	*Formazin Stock Kit
3822-4001	159 001 585	*Calibration Kit, Turbidity, 100, 10 & 0.02 NTU/FNU
3822-4003	159 001 586	*Calibration Kit, Turbidity, 1000, 10 & 0.02 NTU/FNU

* Material Safety Data Sheets (MSDS) are available online at www.gfsignet.com.

** signet-specialproduct@georgfischer.com.



Georg Fischer Signet LLC, 3401 Aero Jet Avenue, El Monte, CA 91731-2882 U.S.A. • Tel. (626) 571-2770 • Fax (626) 573-2057
For Worldwide Sales and Service, visit our website: www.gfsignet.com • Or call (in the U.S.): (800) 854-4090
For the most up-to-date information, please refer to our website at www.gfsignet.com